

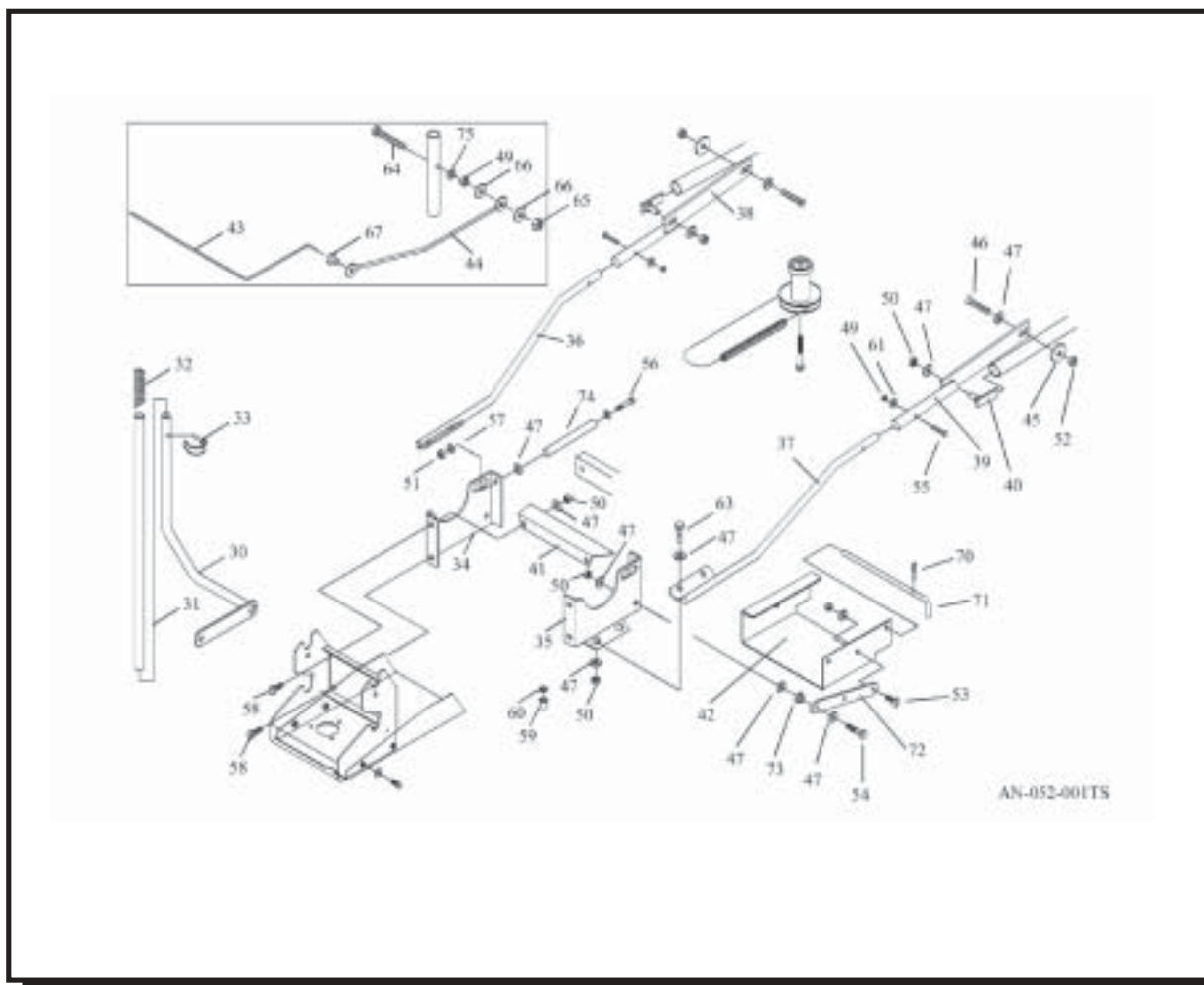

- Ⓚ Ersatzteilliste
- Ⓛ Pièces détachées
- Ⓜ Spare parts list
- Ⓜ Lista ricambi
- Ⓝ Deleliste

Copyright © 2002 by Julius Tielbürger GmbH & Co. KG, Stemwede Nachdruck, auch auszugsweise nicht gestattet. KR-361-065TS 03/2006-1

AN-052-001TS



Wichtig





Die Spalte „Bemerkung“ hilft Ihnen, Teile zu identifizieren.

Verwenden Sie ausschließlich Originalersatzteile vom Hersteller. Dadurch wird die sichere Funktion des Gerätes gewährleistet.

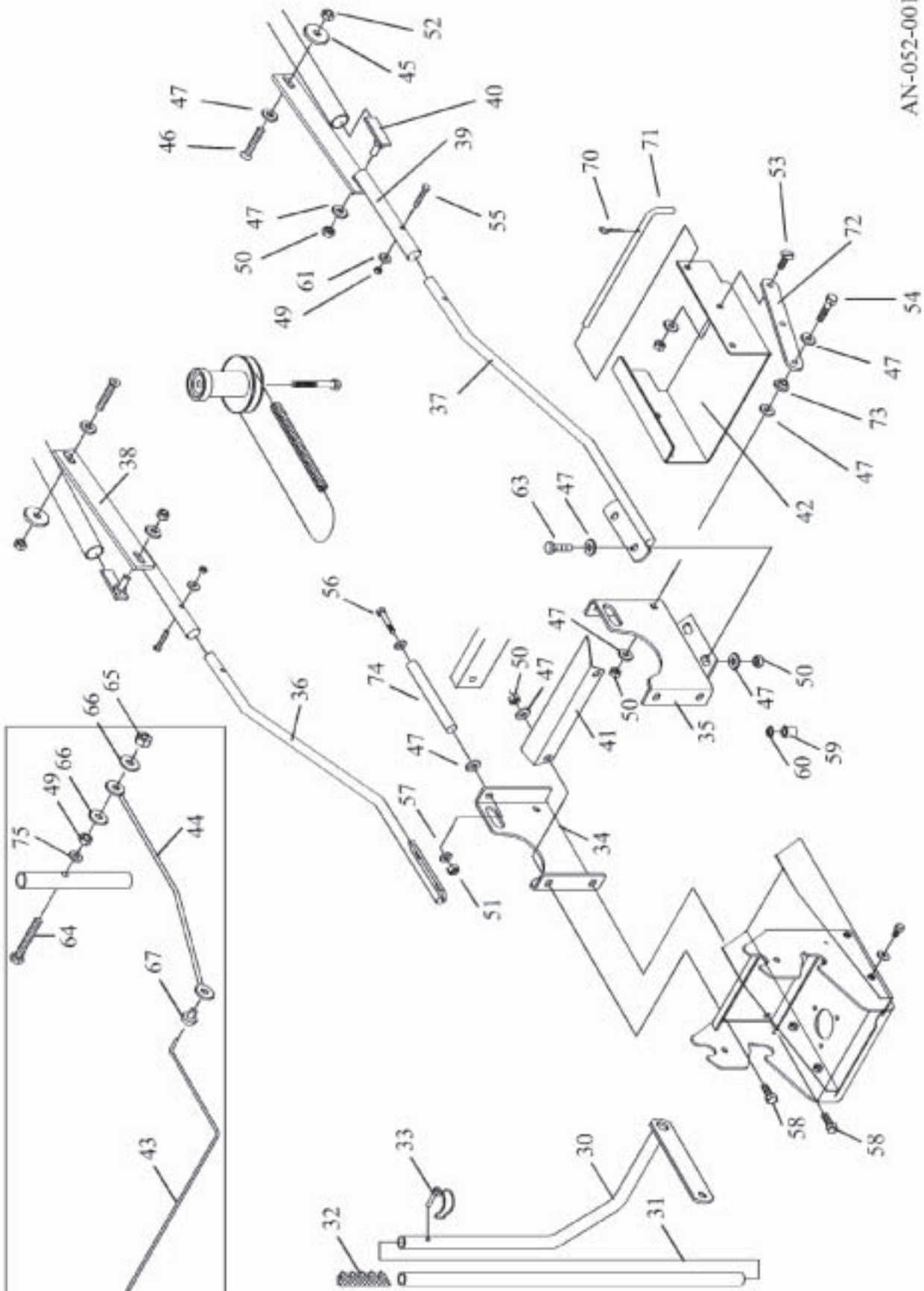
Positionsnummern in Klammern sind Verschleißteile.

AN-052-001TS



Pos.-Nr. Rep. Pos. Pos. Bilde-Nr.	Bestellnummer Référence Article number Nr. codice Bestillings-Nr.	Anzahl Qté. Quant. Q.tà Antall		Désignation 	Description 	Descrizione 	Benevnelse 	Bemerkung
30	AN-001-143-9005	1		Levier	Lever	Leva	Hendel	
31	DN-090-026-9005	1		Tuyau	Tube	Tubo	Rør	
32	HJ-010-013	1		Poignée	Handle	Leva	Handtak	
33	AZ-008-008z	1		Goupille	Hinged pin	Spina sicurezza	Orepinne	
34	DA-332-096-9005	1		Support droite	Carrier right	Supporto dx destro	Holder høyre	
35	DA-332-199-9005	1		Support gauche	Carrier left	Supporto sx sinistro	Holder venstre	
36	AN-052-140-9005	1		Support droite	Bracket right	Supporto dx destro	Støtte høyre	
37	AN-052-141-9005	1		Support gauche	Bracket left	Supporto sx sinistro	Støttevenstre	
38	AN-052-144-9005	1		Support droite	Stud oder bracket (Flach)right	Supporto dx destro	Holder høyre	
39	AN-052-145-9005	1		Support gauche	Stud oder bracket (Flach)left	Supporto sx sinistro	Holder venstre	
40	AN-052-143z	2		Bride	Clamping piece	Particolare di bloccaggio	Klemmestykke	
41	DA-180-199-9005	1		Protecteur	Protector	Protezione	Deksel	
42	DA-240-361-9005	1		Protecteur	Protection oder Cover	Protezione	Deksel	
(43)	HI-040-025z	1		Support	Stud oder bracket (Flach)	Supporto	Holder	
44	AN-043-143-9005	1		Support	Stud oder bracket (Flach)	Supporto	Holder	
45	DA-332-120z	2		Rondelle	Washer	Rondella	Skive	Ø40 mm
46	HO-010-120z	2		Vis à six pans	Hexagon bolt	Vite esagonale	Sekskantskrue	M 10 x 55
47	HW-050-009z	28		Rondelle	Washer	Rondella	Skive	10,5
49	HR-010-004z	3		écrou à six pans	Hexagon nut	Dado esagonale	Sekskantmutter	M 6
50	HR-010-006z	16		écrou à six pans	Hexagon nut	Dado esagonale	Sekskantmutter	M 10
51	HR-030-005z	2		écrou de sûreté	Locknut	Dado autobloccante	Låsemutter	M 8
52	HR-030-006z	2		écrou de sûreté	Locknut	Dado autobloccante	Låsemutter	M 10
53	HO-032-114z	4		Vis à tête bombée	Cut head bolt	Vite testa tonda	Flatrundskruue	M 10 x 25
54	HO-010-118z	2		Vis à six pans	Hexagon bolt	Vite esagonale	Sekskantskrue	M 10 x 45
55	HO-010-059z	2		Vis à six pans	Hexagon bolt	Vite esagonale	Sekskantskrue	M 6 x 40
56	HO-010-092z	2		Vis à six pans	Hexagon bolt	Vite esagonale	Sekskantskrue	M 8 x 65
57	HW-010-007z	4		Rondelle	Washer	Rondella	Skive	8,4
58	HO-020-114z	4		Vis à six pans	Hexagon bolt	Vite esagonale	Sekskantskrue	M 10 x 25
59	DC-161-0114z	2		Douille d'écartement	Spacer tube	Boccola distanziale	Avstandshylse	
60	HU-040-009	2		Anneau d'arrêt	Retaining ring	Segger	Semering	
61	HW-010-004z	2		Rondelle	Washer	Rondella	Skive	6,4
63	HO-020-115z	4		Vis à six pans	Hexagon bolt	Vite esagonale	Sekskantskrue	M 10 x 30
64	HO-010-060z	1		Vis à six pans	Hexagon bolt	Vite esagonale	Sekskantskrue	M 6 x 45
65	HR-030-004z	1		écrou de sûreté	Locknut	Dado autobloccante	Låsemutter	M 6
(66)	HI-040-009	2		Ressort	Belleville washer	Molla tazza	Fjærskive	
67	HK-005-010	1		Gummi				
70 1				Support de fiche	Hairpin clip	Spina elastica	Låsesplint	
71 1				Boulon	Pin	Bullone	Bolt	
72 2				Fer plat	Steel bar	Piatto	Flattjern	
73 2				Distanzhülse mit Bund				
74 2				Entretoise	Spacer	Distanziale	Distansestykke	
75 1				Rondelle	Washer	Rondella	Skive	