

ERGO

...wir lassen nichts liegen

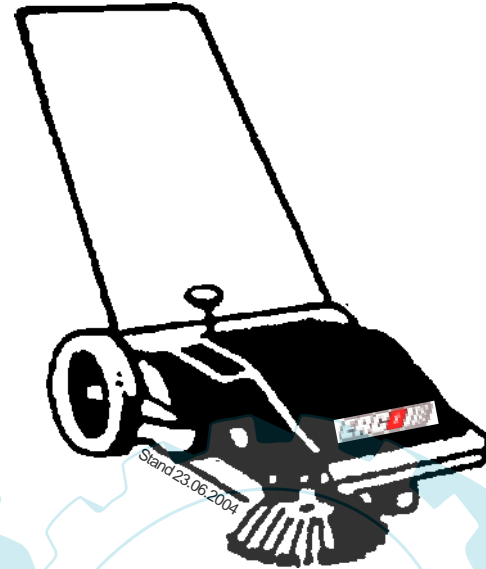

ERSATZTEILLISTE

Kehrsaugmaschine ER-Picobello 150

**ECHO-Motorgeräte
Vertrieb Deutschland GmbH
Otto-Schott-Str. 7**

72555 Metzingen

**Telefon 07123-1091
Telefax 07123-2589
<http://www.echo-shop.de>
email: info@echo-shop.de**



Bild 1

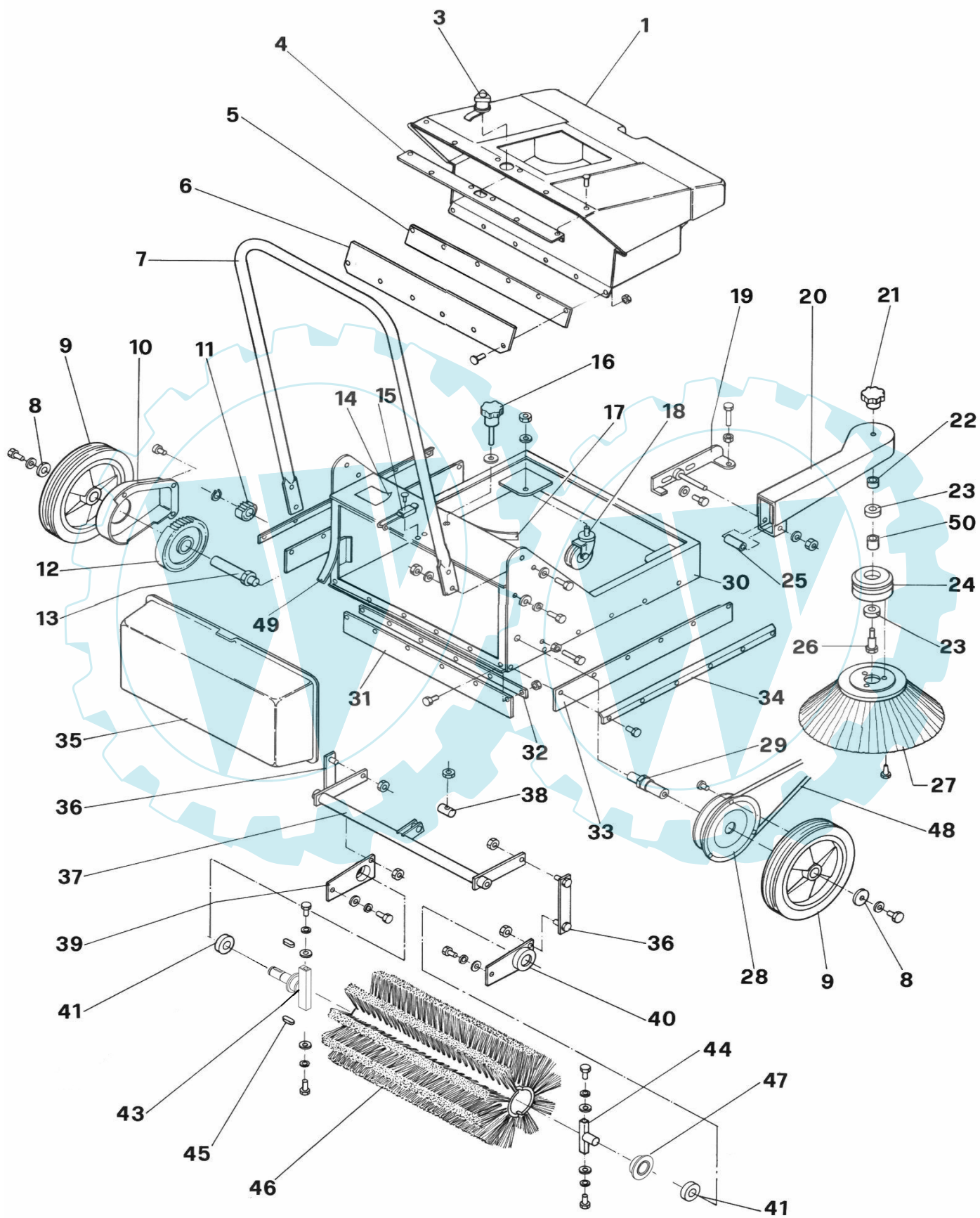



Ersatzteilliste ER-Picobello 150

Bild	Artikelnummer	Anzahl	Bezeichnung
1	07-310041	1	Behälter vorn
3	07-580044	1	Verschluss
4	07-120118	1	Halterung
5	07-340016	1	Gummi am Behälter
6	07-110001	1	Klemmschiene
7	07-160001	1	Griff
8	07-210005	2	Scheibe
9	07-440001	2	Rad hinten
10	07-310003	1	Schutz
11	07-320002	1	Kleines Getriebe
12	07-320001	1	Grosses Getriebe
13	07-210004	1	Bolzen rad links
14	07-510009	1	Aufkleber Buerste
15	07-580001	1	Verschlussshaken
16	07-330058	1	Handgriff
17	07-M30069	1	Dichtung
18	07-440002	2	Rad vorn
19	07-130001	1	Supportarm
20	07-120002	1	Arm der Buerste links
21	07-330004	1	Sterngriff
22	07-210002	1	Distanzbuechse
23	07-410001	2	Lager
24	07-280001	1	PVC Riemenscheibe
25	07-210126	1	Distanzbuchse
26	07-210003	1	Bolzen
27	07-520002	1	Seitenbürste
28	07-190001	1	Riemenscheibe Rad
29	07-210001	1	Bolzen Rad rechts
30	07-120001	1	Chassis
31	07-340075	1	Dichtstreifen hinten
32	07-110003	1	Klemmschiene hinten
33	07-340003	2	Dichtstreifen
34	07-110004	2	Klemmschiene seitlich
35	07-310002	1	Behälter hinten
36	07-130005	2	Verbindung Halterung Bügel
37	07-130002	1	Bügel
38	07-220001	1	Bolzen
39	07-130003	1	Halterung
40	07-130004	1	Halterung
41	07-410002	2	Lager
43	07-130194	1	Halterung Hauptbürste rechts
44	07-130007	1	Halterung Hauptbürste rechts
45	07-750001	2	Keil
46	07-520001	1	Hauptbürste
47	07-220039	1	Distanzbuchse
48	07-430001	1	Riemen
49	07-M30069	1	Dichtung
**	07-490005	/	Set Ersatzgummis
50	07-210261	1	Distanzbuechse



Bild 2

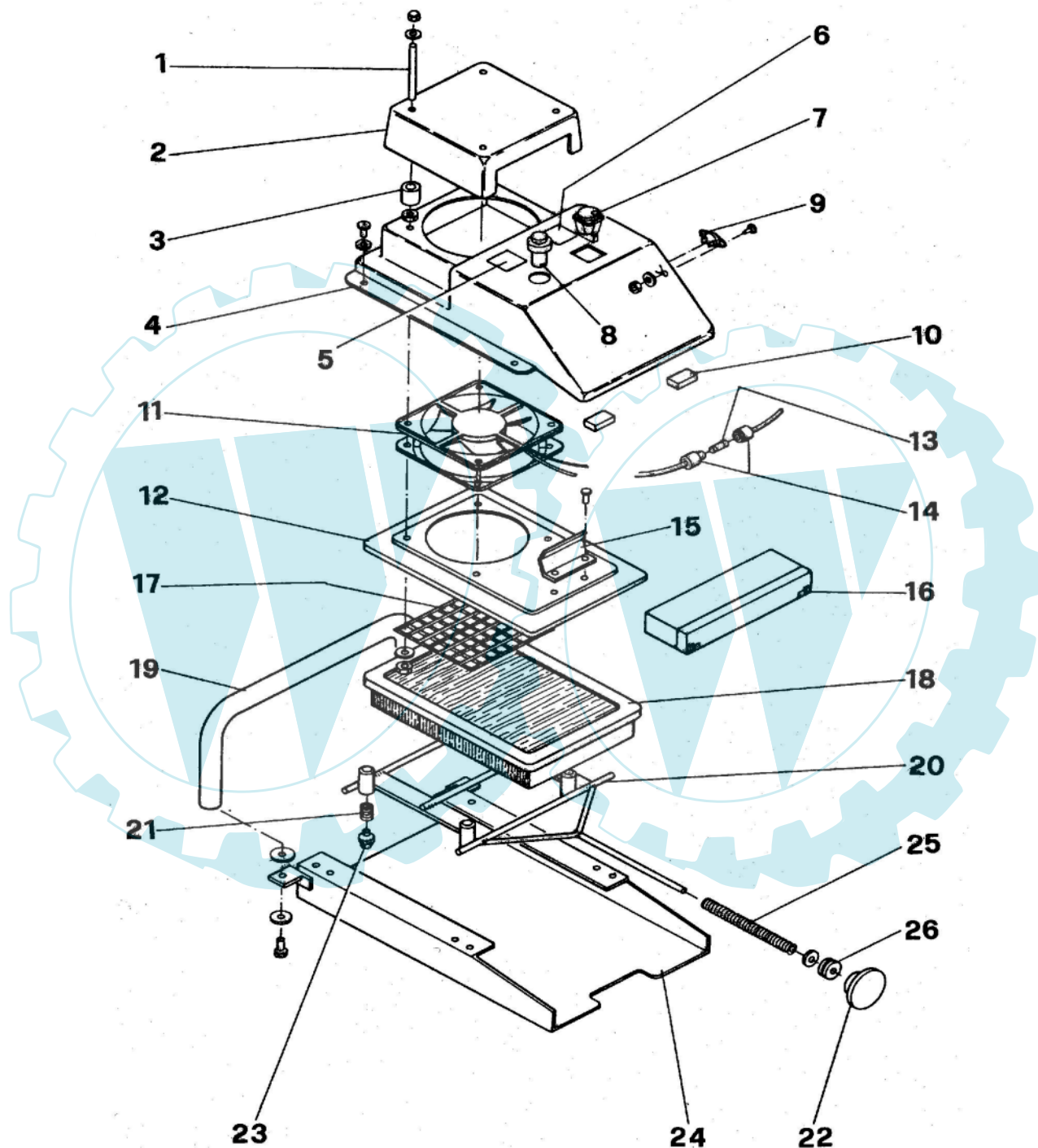







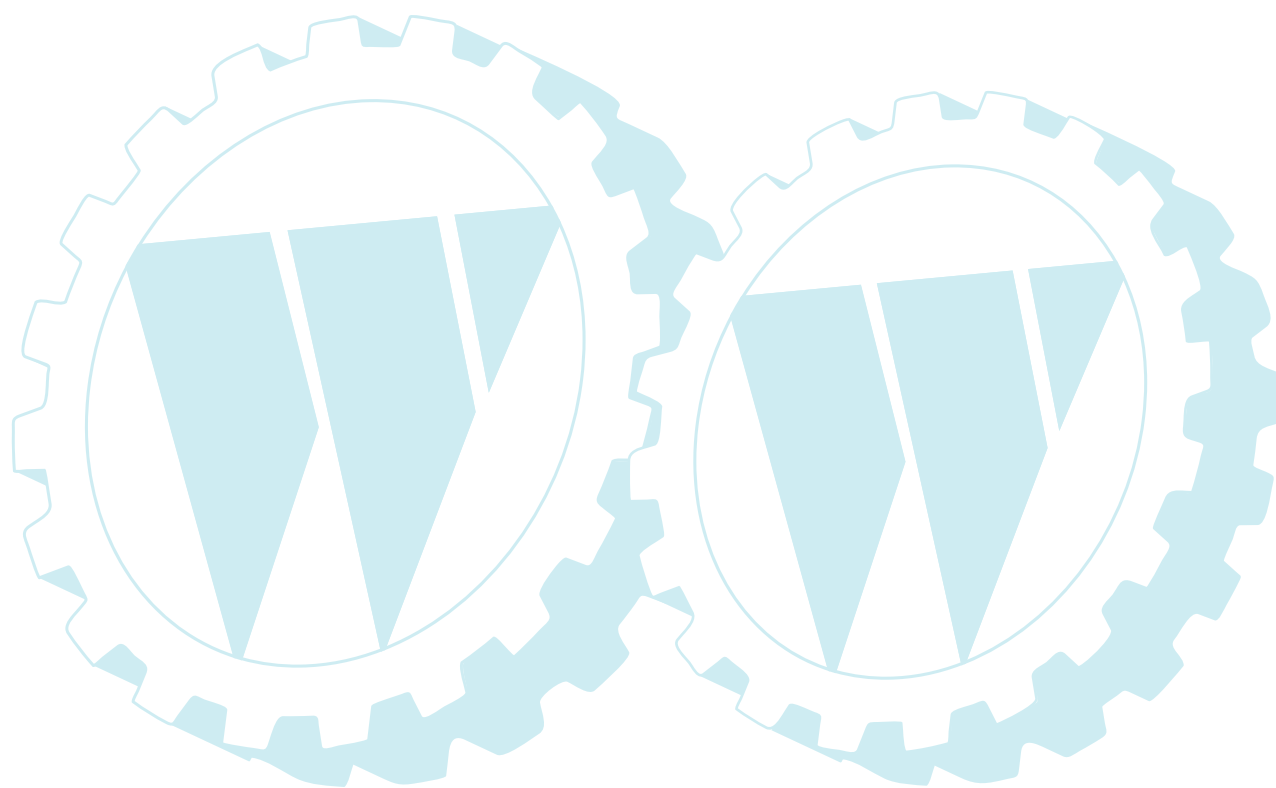

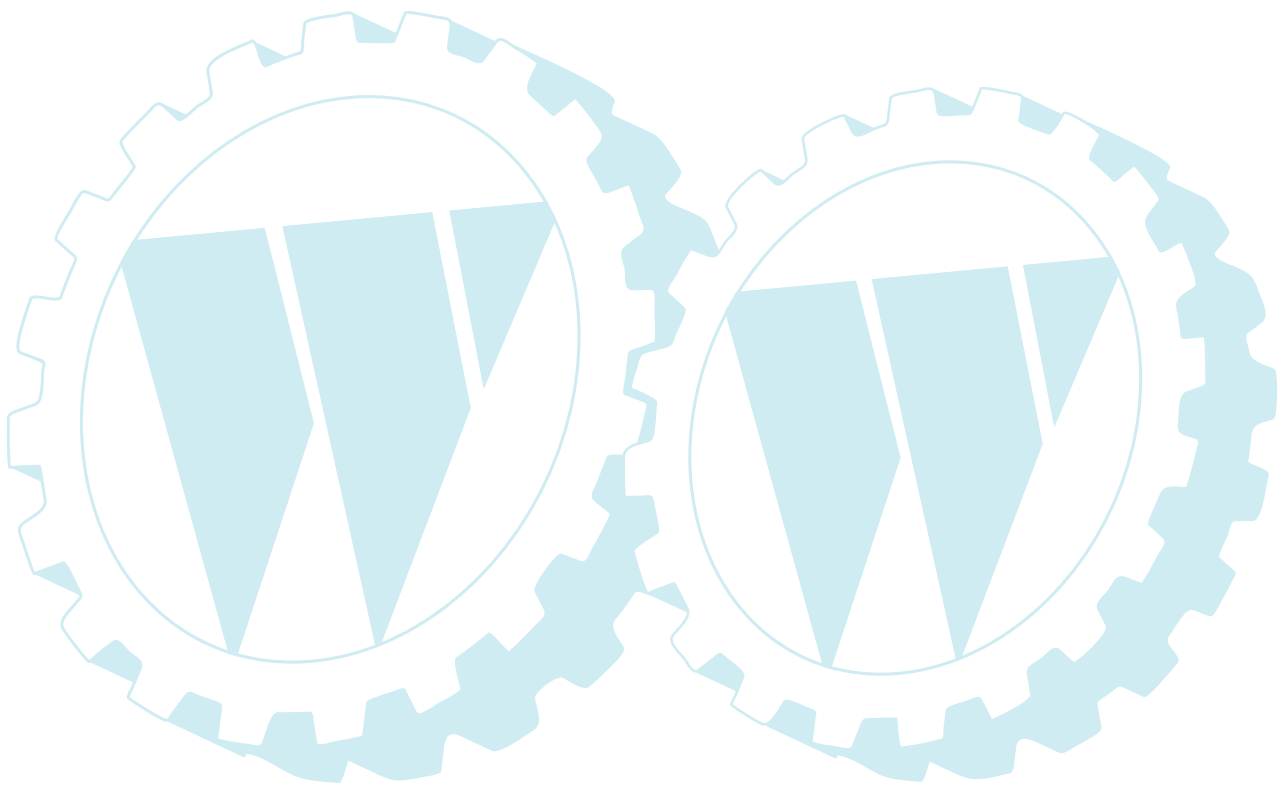





Ersatzteilliste ER-Picobello 150

Bild	Artikelnummer	Anzahl	Bezeichnung
1	07-110093	4	Feinblech
2	07-310040	1	Luft Ausblas Bedeckung
3	07-210090	1	Distanzbuchse
4	07-310039	1	Gehäuse Oberteil
5	07-510055	1	Aufkleber
6	07-510056	1	Aufkleber
7	07-660024	1	Zweipolig Schalter
8	07-900419	1	Entlademelder
9	07-640141	1	Paar Verbindungen
10	07-340014	4	Aufkleber
11	07-610010	1	Absauger
12	07-310038	1	Filter Abdeckung
13	07-640050	1	Sicherung 1A
14	07-640049	1	Sicherungshalter
15	07-110094	1	Batteriehalter
16	07-620017	1	Batterie 12V
17	07-110144	1	Schutz
18	07-520023	1	Filter
19	07-180007	1	Behälter Griff
20	07-130072	1	Filterrüttler
21	07-550023	4	Feder
22	07-210092	1	Griff
23	07-210091	4	Bolzen
24	07-120119	1	Gehäuse Unterteil
25	07-550024	1	Feder
26	07-330056	1	Gummi



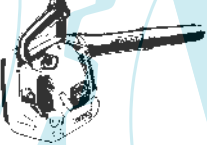
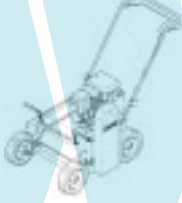
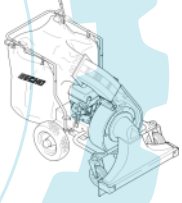

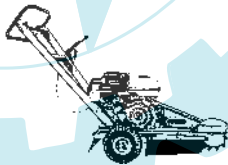
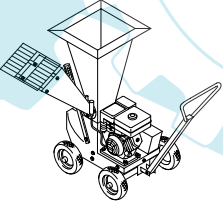
Wir bezeichnen uns als die besten Spezialisten für Pflorgetechnik im Aussenbereich zwischen 1.000 m² und 20.000 m² mit einer hervorragenden Serviceorganisation.

				
Motorsägen	Trennschneider	Rückenspritze	Bohrgerät	Hochentaster
				
Motorsensen	Heckenscheren	Blasgeräte	Vertikutierer	Laubsauger
				
Großbläser	Stumpenfräse	Häckselwölfe	Rasentraktoren	Kehrmaschinen

Grundstückspflege ist unsere Stärke

überreicht durch: