

KREISELRASENMÄHER

GR292-----A

TYPE 1

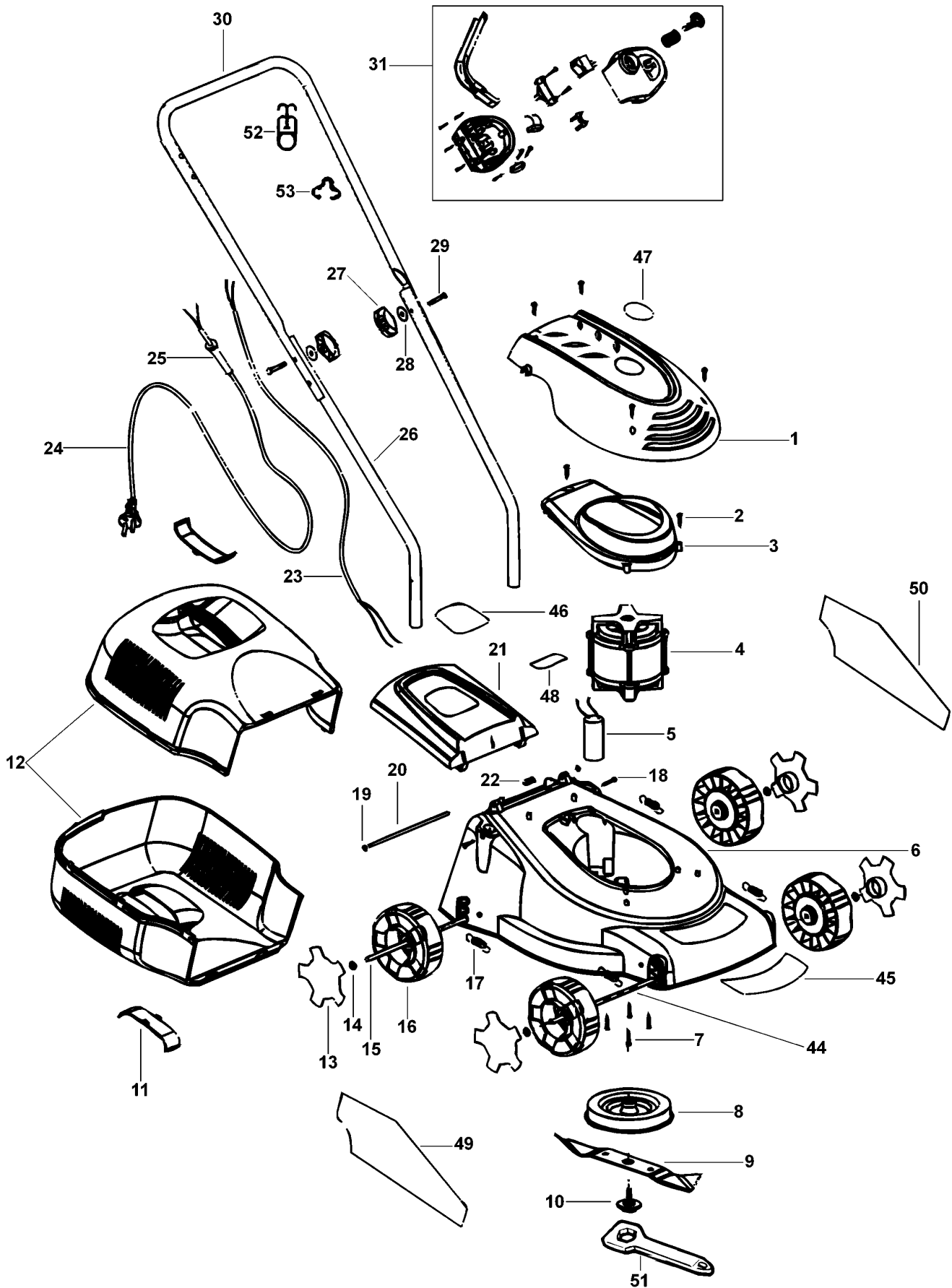

©

KREISELRASENMÄHER

GR292-----A

TYPE 1



Pos. Nr	Ersatzteilnummer	Beschreibung	Preis	Variants
1	1	596027-00	ABDECKUNG	
2	3	596028-00	SCHRAUBE	
3	1	596029-00	MOTORABDECKUNG	
4	1	596030-00	MOTOR	
5	1	596031-00	KONDENSATOR	
6	1	596032-00	FRASER BODEN	
7	4	596033-00	SCHRAUBE	
8	1	596034-00	LÜFTER	
9	1	596035-00	MESSER	
10	1	596036-00	BOLZEN	
11	2	596037-00	EINSATZ	
12	1	596038-00	GRASFANGSACK	
13	4	596039-00	ABDECKUNG	
14	4	596040-00	FESTSTELLRING	
15	1	596041-00	ACHSE	
16	4	596042-00	RAD	
17	4	596043-00	FEDER	
18	2	596044-00	SCHRAUBE	
19	2	596045-00	RING	
20	1	596046-00	STANGE	
21	1	596047-00	GRASSFLAP	
22	1	596048-00	FEDER	
23	1	596049-00	MOTORKABEL	
24	1	596050-00	KABELSATZ	GB
25	1	596051-00	KABELTUELLE	
26	2	596052-00	UNTERER GRIFF	
27	2	596053-00	KNOPF	
28	2	596054-00	UNTERLEGSCHEIBE	
29	2	596055-00	BOLZEN	
30	1	596056-00	OBERER GRIFF	
31	1	596087-00	SCHALTER ZSB	GB
31	1	596088-00	SCHALTER ZSB	CH
31	1	596057-00	SCHALTER ZSB	QS
44	1	596089-00	ACHSE	
45	1	596090-00	TYPENSCHILD	
46	1	596091-00	AUFKLEBER	
47	1	596092-00	WARNSCHILD	
48	1	596058-00	AUFKLEBER	
49	1	596059-00	SCHILD	
50	1	596060-00	SCHILD	
51	1	597564-00	SCHLUESSEL	
52	1	597565-00	KABELFÜHRUNG	
53	1	597566-00	HALTKLAMMER	